

5 FT LAYOUT DIAGRAM

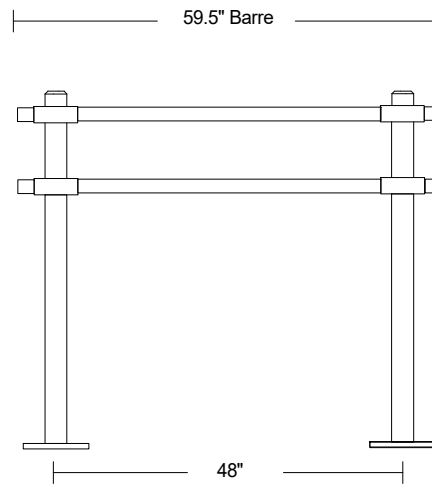

System Components:

- 2) Floor Stanchions
- 2) 59.5" Barres
- 8) Barre to Collar Screws

VITA VIBE, Inc.
40 Ellwood Ct. - Greenville, SC 29607
Tel: 864-288-8934 Fax: 864-751-6302

Proudly
Manufactured
In The USA